





38J - Island Moss with Sierra Maple

WE MADE THE BEST-SELLING CLASS A MOTOR HOME EVEN BETTER.

At Winnebago Industries, we listen to RV enthusiasts, rigorously test components and conduct extensive field trials to continuously improve the Adventurer. Featuring all the comforts of home and a long list of available premium amenities, the 2005 Adventurer is designed with one goal in mind — your comfort.

Additional seat belts have been added to the dining area, giving you more seating options while traveling. The RV Radio® with its large, easy-to-operate controls, comes standard, and new this year are two remotes: one is hand-held, the other is mounted to the steering wheel. Or choose the available Kenwood® Sirius® Satellite Receiver. It comes with a complimentary one year subscription.

Premium items include flat-face TVs in the lounge and bedroom. A rear stereo system and Sleep Number® Bed by Select Comfort® are available in the bedroom. Solid-surface countertops are standard in the galley and available GPS system will help keep you on track during your travels. Read on, and learn which Adventurer is just right for you.



IT'S ALL INSIDE.

Step into the Adventurer's spacious interior and enjoy a comfortable, roomy living area loaded with Smart Space™ design elements. Smart Space is our design philosophy that makes the most of each available inch by maximizing functionality and user-friendly features. Relax at the available residential-style dining table with four chairs. Or stretch out on the premium Stitchcraft furniture and watch the 24" flat-screen TV found in the front entertainment center (27" TV on 37B, 38J and 38R).

Choose from three striking interior color schemes and four wood choices to fit your style. Portsmouth Oak, Concert Cherry, Washed Maple or Sierra Maple cabinetry add to the Adventurer's ambiance with their durable and beautiful catalyzed finish.

To help keep you comfortable, standard dual-glazed windows provide increased thermal efficiency. And to control the amount of light and for additional privacy, our standard day/night pleated shades are found in the lounge, dinette and bedroom areas.

The Home Comfort Plus Package includes an auxiliary automotive heater, insulated power roof vents in the bath and galley, and a heat pump for a convenient source of heat on cool mornings without starting the LP-fueled furnace.



35U - Oyster Bay with Washed Maple



A LITTLE SOMETHING FOR EVERYONE.

There's no shortage of entertainment options in the Adventurer, which includes the 24" Sony® flat-face TV with Video Selection System (a 27" TV comes standard with the 37B, 38J and 38R). Additional available features include a DVD/VCR combo and manual, powered or in-motion digital satellite dish, so you'll always be well connected. For movie-theater-quality sound, choose the available Deluxe Sound System with 5-Channel QSurrround.™ To keep you entertained even when you're not connected to shoreline or generator power, select the available 300-watt inverter.

For the gourmet, the galley has everything you'll need to cook up a feast. Solid-surface countertops add functional work space with the flip-up extension and covers for the recessed sink. A water purification system with separate faucet comes standard. A three-burner range with oven and the 30" residential microwave with the sensor cook feature give you flexibility in food preparation. A large four-door refrigerator/freezer with icemaker provides plenty of cold storage and is available on most models, while the spacious pull-out pantry keeps non-perishables stowed away. For an added touch of elegance, choose the available Stainless Steel Package, which includes a stainless steel refrigerator, range and microwave; brushed nickel lighting fixtures; and decorative bath and cabinet hardware throughout.

A



B



C



D



E



F



G



H



I



MORE OF WHAT YOU LOVE.

A,B,C) The BenchMark™ full comfort dinette features innerspring seat cushions and contemporary styling, giving you the look and feel of residential furniture. Flip up the seats to access the large storage spaces or fold down the table to quickly convert the dinette into a comfortable bed (not available on the 38J or 38R). BenchMark also features additional seat belts, providing you with greater seating flexibility while traveling. There's even an anchor for your child's safety seat.

D,E,F) It's a sofa! It's a recliner! It's a bed! It's all three! It's the Rest Easy® multi-position lounge. At the touch of a button, it goes from a sofa to a recliner with a pull-out ottoman. Touch the button again and it's a comfortable bed. Fabric covering is standard or you can upgrade to the available leather. A dual recliner feature is also available. Selected models feature an available fold-down armrest with beverage holder.

G) Arrive refreshed from your travels thanks to the highback cab seats. With multi-position armrests, swivel, recline and slide features, you can adjust to the position that fits you best. Available upgrades include six-way power assist and leather. The hoop-base lounge chair is not only attractive but can be repositioned anywhere you want when the motor home is not moving. It rocks, reclines, has a footrest and is also available in luxurious leather. And a multi-use slide-out lounge table is featured on the 33V, 35U, 37B and 38G. Just the place for your laptop or a cup of coffee.

H) The multi-function table provides dining for two, expands to accommodate four and also functions as a computer or hobby table (available on the 35U and 38G).

I) The dining table is available in most models and provides comfortable dining for two and easily expands to accommodate four place settings to entertain guests.

WELL THOUGHT OUT FROM THE INSIDE OUT.

A) Every part of the dash is designed with the driver's needs in mind. Controls are conveniently located and feature large, easy-to-read switches. Driver and passenger map lights and a new center sunvisor come standard, while power sunvisors, operated with well-placed switches on the driver and passenger trim panels, are also available. The standard dash-mounted compass keeps you pointed in the right direction and indicates the exterior temperature at the touch of a button. The centrally mounted convenience center is easily accessible and includes cupholders and a storage area. Select the available GPS system to keep track of your location. And choose the rearview monitor system built into the dash with one-way audio. It allows you to back up and maneuver with confidence.

B) Pull out the standard passenger-side dash-mounted workstation and you'll find a handy place for using your laptop computer, writing letters or playing cards. There is also a convenient storage area underneath.

C) The OnePlace® systems center places important and frequently used switches, gauges, levels and controls in one convenient location so you can check them at a glance. A courtesy light located above OnePlace allows you to easily locate the monitor panel at night.

D) Upgrade your listening choices with one free year of Sirius Satellite Radio programming when you select the available Kenwood® Sirius Satellite receiver, shown here. High-altitude satellites deliver 100 channels of crystal clear programming anywhere in the United States, without signal fades.

The RV Radio with cassette and CD player features large control knobs; easy-to-operate buttons; and a new, convenient steering wheel remote. When you're parked, use the new hand-held remote.

E) The four available two-way radios have up to a five-mile range and recharge at their built-in charging station.

F) Interior climate control has never been better, thanks to Winnebago Industries' exclusive TrueAir® residential central air conditioning. At the heart of the system is a Coleman®-Mach® unit, located below the floor, which provides a lower vehicle profile, reduces interior noise and enables easier servicing. It also eliminates roof runoff from A/C related condensation and lowers the vehicle's center of gravity.

G) Winnebago Industries' exclusive TrueLevel™ holding tank monitoring system incorporates Mirus™ detector cells to ensure accurate fresh and wastewater tank level readings. Mirus detector cells produce a microelectric field that detects liquid levels from outside the tank. No more probes to corrode or clog. Just true, accurate readings time after time.

A



B



C



D



E



F



G

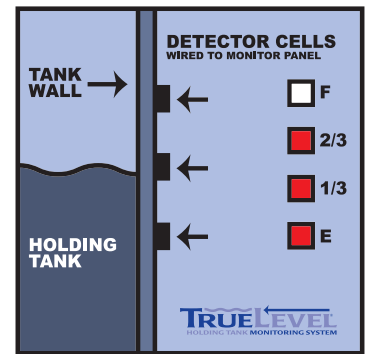



37B - Island Moss with Washed Maple

A BEDROOM THAT OFFERS MORE THAN A GOOD NIGHT'S SLEEP.

The rear slideout creates a bedroom with abundant living and storage space, a clothes hamper (most models), a mirrored wardrobe and a changing area (37B incorporates two rear slideouts). Watch your favorite movie on the bedroom TV, thanks to the infrared remote extender that lets you use the front DVD/VCR remote in the bedroom. You can even upgrade to an available rear stereo system with AM/FM/CD player and alarm clock. Sleep tight on the walk-around queen-size bed with Serta® innerspring mattress.

A) Enjoy a pleasant night's sleep on the available queen-size Sleep Number Bed by Select Comfort. Using the hand-held remotes on each side of the bed, you can quickly and independently adjust the mattress firmness level to your ideal level of comfort and support.

B) A spacious and well-designed bath area awaits and features the Moen® Posi-Temp® control to maintain shower temperature, even when water pressure fluctuates. Available on most models is the shower package with fold-down shower seat and hand-held showerhead.

C) The 37B features a spacious double-slide bedroom with two lounge chairs and tuck-away ottomans. Or opt for one lounge chair with ottoman and a functional desk area. For added storage, the ottomans have a flip-up top.

A



B



C



A



B



C



D



GET AT EVERYTHING WITH EASE.

A) A Winnebago Industries original, StoreMore® is the industry's premium slideout system. StoreMore features large, well-lit exterior storage compartments designed to accommodate bulky and odd-shaped items. Automatic exterior compartment lights are door activated and a master light switch is located in the entrance area. Best of all, these compartments extend along with the slideroom for easy access without crawling under the slideroom. You'll also appreciate how easy it is to open the exterior compartment doors, thanks to single-paddle latches and gas struts.

B) Adventurer comes equipped with an exterior entertainment center that includes AM/FM stereo with an antenna, CD player with remote, 12-volt DC receptacle, TV jack, 110-volt outlet, speakers and a removable table. The compartment locks securely. A hookup for a portable satellite dish in the electrical service center is also included (satellite dish not included).

C) Rinse off muddy or sandy gear outside at the exterior wash station. This heated compartment houses major plumbing and service points. The QuickPort™ service connection hatch features a convenient opening for the electrical cords and hoses to pass through. This unique design allows you to close your compartment doors even when connected to the electrical and sewer hookups at the campground.

D) The sewer hose includes our exclusive QuickConnect™ coupling valve and storage holster for added convenience.

INTERIORS



Available Stainless Steel Package



Island Moss



Loganbrook



Oyster Bay



Concert Cherry



Portsmouth Oak



Sierra Maple



Washed Maple

THE SAME STANDARDS INSIDE AND OUT.

We believe the same high standards we apply to construction should apply to interior design. That's why we design efficient floorplans based on customer input, why we look for durable fabrics in pleasing colors, and why we handcraft our own cabinets using traditional panel and rail construction.

EXTERIORS AND FLOORPLANS

Standard Graphics



Light Autumnwood Metallic



Titanium Metallic

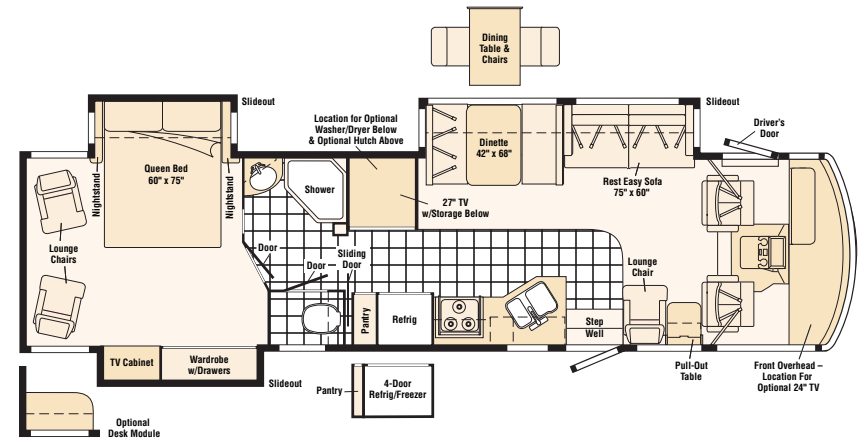
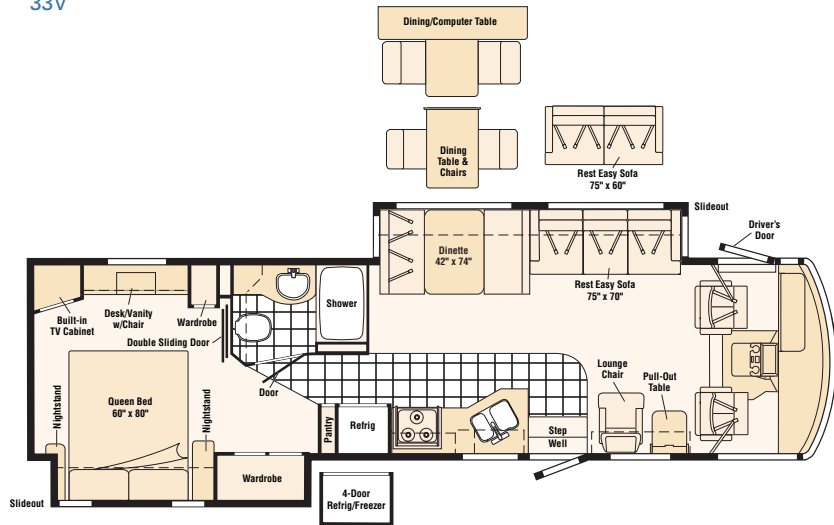
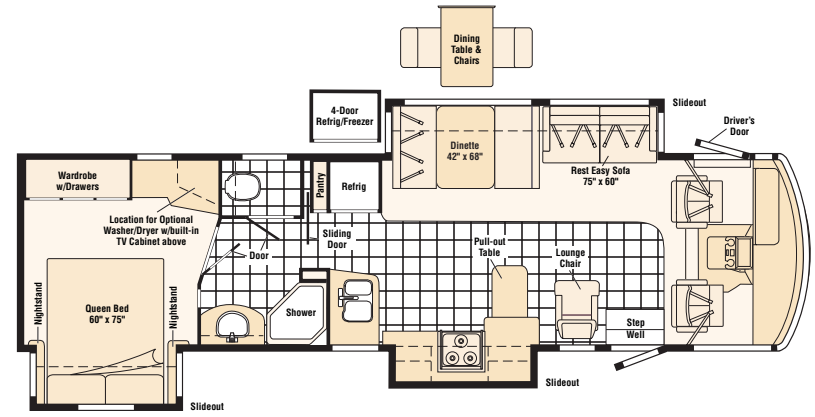
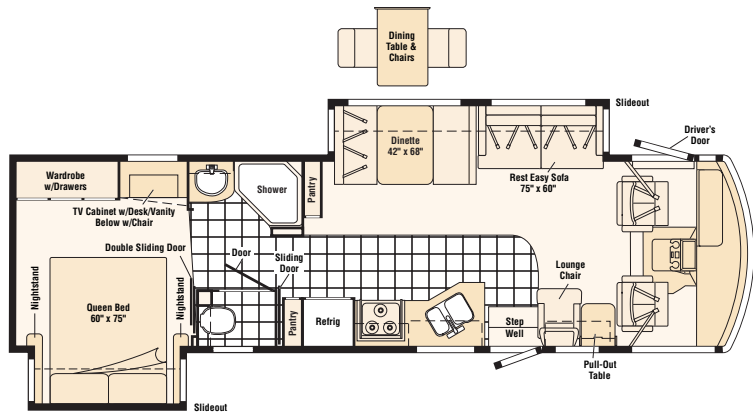

33V

35A

35U

37B

EXTERIORS AND FLOORPLANS

Available Full Body Paint



Denim



Sage

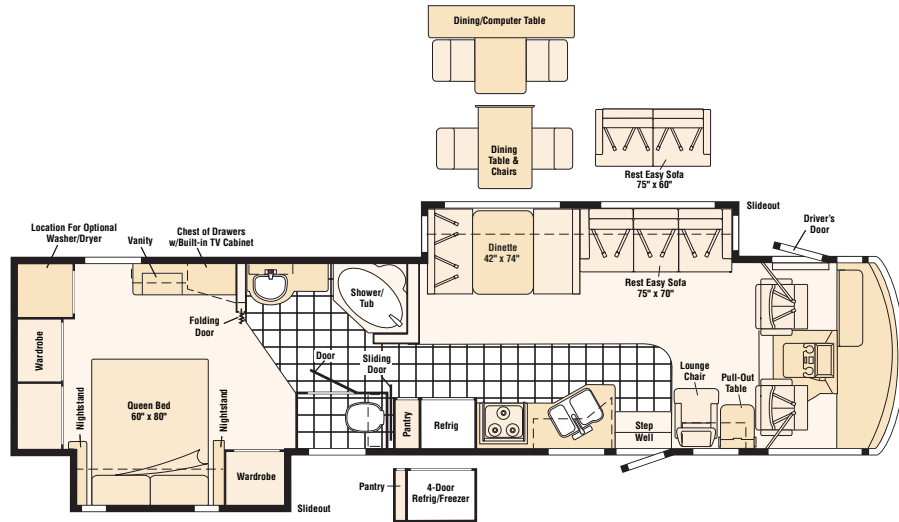

38G

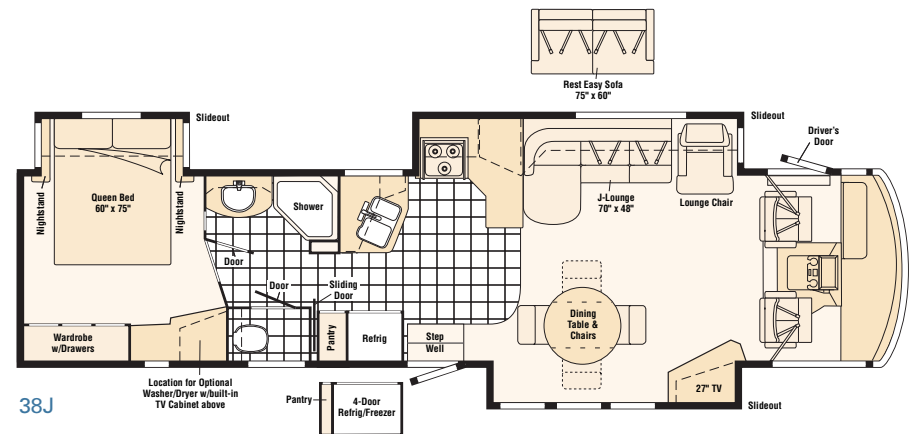

38J

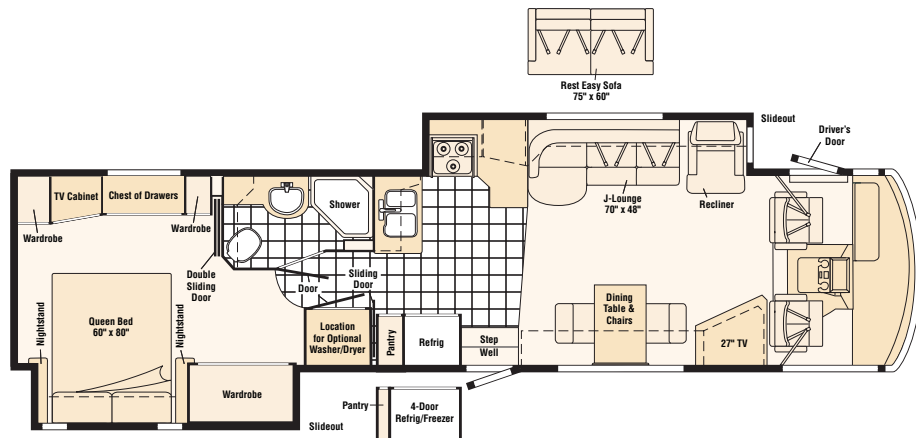

38R



Note: Dimensions shown are for sleeping space only and may vary due to styling differences. Dashed lines denote overhead storage areas.

2005 WINNEBAGO ADVENTURER® SPECIFICATIONS

	33V	35A	35U	37B	38G	38J	38R
Length	33'7"	35'10"	35'7"	37'11"	38'2"	38'9"	38'11"
Exterior Height^a – F/W	11'5" / 11'8"	11'8" / 11'7"	11'8" / 11'7"	11'7"	11'7" / 11'6"	11'6"	11'5"
Exterior Width^b	8'6"	8'6"	8'6"	8'6"	8'6"	8'6"	8'6"
Exterior Storage^c (cu. ft.)	52.7	77.7	78.4	88.1	78.5	83.0	106.8
Interior Height	6'8"	6'8"	6'8"	6'8"	6'8"	6'8"	6'8"
Interior Width	8'1"	8'1"	8'1"	8'1"	8'1"	8'1"	8'1"
Fresh Water Capacity w/Heater^d (gal.)	90	92	90	82	85	92	92
Holding Tank Capacity^d – Black/Gray (gal.)	55 / 44	51 / 77	45 / 50	51 / 58	51 / 54	51 / 54	45 / 50
LP Capacity^e (gal.)	28	28	28	28	28	28	28
Fuel Capacity (gal.)	75	75	75	75	75	75	75
GCWR (lbs.)^f	26,000 ● / 26,000 □ / 26,000 ○	26,000 ■ / 26,000 ○ / 30,000 △	26,000 ■ / 26,000 ○	26,000 ○ / 30,000 △	26,000 ■ / 26,000 ○ / 30,000 △	30,000 △	26,000 ○ / 30,000 △
GVWR (lbs.)	20,500 ● / 20,700 □ / 22,000 ○	22,000 ■ / 22,000 ○ / 24,000 △	22,000 ○ / 22,000 ○	22,000 ○ / 24,000 △	22,000 ○ / 22,000 ○ / 24,000 △	24,000 △	22,000 ○ / 24,000 △
GAWR – Front (lbs.)	7,000 ● / 7,500 □ / 8,500 ○	7,500 ■ / 8,500 ○ / 9,000 △	7,500 ■ / 8,500 ○	8,500 ○ / 9,000 △	7,500 ■ / 8,500 ○ / 9,000 △	9,000 △	8,500 ○ / 9,000 △
GAWR – Rear (lbs.)	13,500 ● / 13,500 □ / 15,000 ○	14,500 ■ / 15,000 ○ / 15,500 △	14,500 ■ / 15,000 ○	15,000 ○ / 15,500 △	14,500 ■ / 15,000 ○ / 15,500 △	15,500 △	15,000 ○ / 15,500 △
Wheelbase	208"	228"	228"	248"	248"	248"	248"

F = Ford® W = Workhorse™ ■ = Chassis A ● = Chassis B □ = Chassis C ○ = Chassis D △ = Chassis E

Standard - S Optional - O 33V 35A 35U 37B 38G 38J 38R

AUTOMOTIVE

	33V	35A	35U	37B	38G	38J	38R
Chassis A - Ford® 6.8L Super-Duty V10 SOHC Triton® engine, 310-hp, 4R100 electronic, 4-speed overdrive transmission, 130-amp. alternator, 4-wheel ABS, Tire 22.5" , Wheel Liners stylized aluminum		O	S		S		
Chassis B - Ford 6.8L Super-Duty V10 SOHC Triton engine, 310-hp, 4R100 electronic, 4-speed overdrive transmission, 130-amp. alternator, 4-wheel ABS, Tire 19.5" , Wheel Liners stainless steel	S						
Chassis C - Workhorse™ 8.1L Vortec V8, 340-hp, Allison® 1000 electronic 5-speed overdrive transmission, 145-amp. alternator, 4-wheel ABS, Tire 19.5" , Wheel Liners stainless steel	O						
Chassis D - Workhorse 8.1L Vortec V8, 340-hp, Allison 1000 electronic 5-speed overdrive transmission, 145-amp. alternator, 4-wheel ABS, Tire 22.5" , Wheel Liners stainless steel	O	S	O	S	O		S
Chassis E - Workhorse 8.1L Vortec V8, 340-hp, Allison 1000 electronic 5-speed overdrive transmission, 145-amp. alternator, 4-wheel ABS, Tire 22.5" , Wheel Liners stainless steel		O		O	O	S	O
Leveling Jacks HWH® hydraulic, manual touch pad w/chime, Tire Tools wrench, leverage bar, Trailer Hitch 1 5,000-lbs. drawbar/500-lbs. maximum vertical tongue weight ¹ & wiring	S	S	S	S	S	S	S
Wheels stylized aluminum w/Workhorse 22,000-lbs. or 24,000-lbs. chassis (22.5" tires only)	O	O	O	O	O	O	O

CAB AREA & DRIVER CONVENIENCES

	33V	35A	35U	37B	38G	38J	38R
Cab Seats (Fabric) w/3-point adjustable seat belts, multi-position armrests, headrest, manually adjustable lumbar support, multi-adjustable swivel/slide/recline, Cab Sound Control Package , Cigarette Lighter/12-Volt DC Powerpoint , Compass electronic w/outdoor thermometer, Convenience Tray , Cruise Control , Door driver w/power window, assist bar, KeyOne™ System (common key w/entrance door & exterior storage compartments), trim panel w/beverage holder, storage pocket, switch applique, power mirror controls, Courtesy Light , Floor Mats carpet driver & passenger, Instrument Panel applique, Map Lights , Shades light filtering, cab windows & front wraparound, Trim Panel passenger side w/beverage holder, storage, 12-volt DC powerpoint, Steering Wheel tilt w/power assist, Sunvisors (3) (37B center-mount sunvisor NA w/front TV option), Window (passenger) full-slider w/screen, dual-glazed/thermo-insulated, Windshield Wipers intermittent, Workstation in dash	S	S	S	S	S	S	S
Cab Seats (Leather w/vinyl surround) manual adjustable lumbar support, Cab Seat Pedestal 6-way power assist (driver), Cab Seat Pedestal 6-way power assist (driver & passenger), Defroster Fans (2) auxiliary 2-speed w/instrument panel switch, GPS Navigation System , Monitor System rearview w/single camera & 1-way audio, Sony, Sunvisors (2) powered, switch	O	O	O	O	O	O	O

ENTERTAINMENT

	33V	35A	35U	37B	38G	38J	38R
CB Prep antenna, antenna lead, 12-volt DC powerpoint, Entertainment Center (Exterior) w/CD Player DC receptacle, AC duplex receptacle, AM/FM radio, exterior antenna jack, TV jack, radio antenna, speakers (2), lockable compartment, removable table, Bluetooth (Cab) AM/FM/stereo cassette/CD player w/weather band, remotes, roof-mounted flexible rubber antenna, speakers (4), Radio Power Switch main/auxiliary battery, Satellite System Ready , Telephone input & interior jacks, TV Enhancement Package antenna (amplified), interior jacks, coax wiring, cable input, antenna check reminder light, Video Selection System	S	S	S	S	S	S	S

33V 35A 35U 37B 38G 38J 38R

	33V	35A	35U	37B	38G	38J	38R
Compact Multi-Disc Changer, DVD/VCR Stereo combo w/remote, Sony, Radio Satellite , Sirius Kenwood Receiver, Radios (4) 2-way docking port w/charger, Satellite Dish Antenna RV digital, elevation sensing unit, manual, Winegard® Satellite Dish Antenna RV digital, power or in-motion, Winegard, Sound System Deluxe w/QSurround amplifier, recessed speakers (5), sub-woofers (2), Stereo System (rear) AM/FM/CD player, alarm clock	O	O	O	O	O	O	O
Entertainment Center TV 27" flat-screen, stereo color AC w/remote, Sony				S		S	S
TV 20" flat-screen, color AC w/remote, remote extenders, bedroom, RCA®	S	S	S		S	S	S
TV 24" flat-screen, color AC w/remote, remote extenders, bedroom, Sony				S			
TV 24" flat-screen, stereo color AC w/remote, Sony	S	S	S	O	S		
TV 24" flat-screen, stereo color AC w/remote, Sony, and hutch cabinet				O			

INTERIOR

	33V	35A	35U	37B	38G	38J	38R
Accessory Package rechargeable flashlight, rechargeable vacuum cleaner, Ceiling fabric, Clock, Lights ceiling, incandescent, bath, bedroom w/wall switches, Light decorative oval, Lights fluorescent, recessed, galley, lounge w/wall switches, Lights reading, Mini Blinds galley & bath, Shades day/night pleated, lounge, dinette, & bedroom, Windows flush-mounted, dual-glazed, thermo-insulated	S	S	S	S	S	S	S
Cupholder(s)						S	S
Light wall lamp (lounge area)			S		S		
Picture framed		S				S	S
Mirror	S		S		S		

CABINETRY

	33V	35A	35U	37B	38G	38J	38R
Portsmouth Oak or Concert Cherry or Washed Maple or Sierra Maple stile-and-rail construction w/raised panel inserts on upper doors	O	O	O	O	O	O	O

FLOORCOVERING

	33V	35A	35U	37B	38G	38J	38R
Carpeting w/pad, Vinyl Tile bath, galley	S	S	S	S	S	S	S

FURNITURE

	33V	35A	35U	37B	38G	38J	38R
Dining Table & Chairs ⁹ (2) free standing, (2) folding, extendable table w/pull-up leaf (free-standing round table 38J),	O	O	O	O	O	S	S
BenchMark Full Comfort Dinette access to storage below, child seat tether anchor, Lounge Chair ⁹ (Fabric) hoop-base, cabinet w/pull-out table, (NA 35A) recliner, rocker, footrest, handle	S	S	S	S	S		
Lounge Chair (Leather) hoop-base, Recliner Multi-Position Lounge (Leather) dual control	O	O	O	O	O	O	O
Lounge Chair (Fabric) hoop-base, recliner, rocker, footrest						S	S
Multi-Purpose Table & Chairs ⁹ (2) free standing, (2) folding			O		O		
Recliner Multi-Position Lounge (Fabric) throw pillows & fold-down armrest w/beverage holder	S	S		S		O	O

2005 WINNEBAGO ADVENTURER® SPECIFICATIONS

Standard - S	Optional - O	33V	35A	35U	37B	38G	38J	38R
Rest Easy® Multi-Position Lounge (Fabric) power recliners, dual trundle storage				S		S		
Rest Easy® Multi-Position Lounge (Leather) fold-down armrest w/beverage holder	O	O		O				
Rest Easy® Multi-Position Lounge (Leather)				O		O	O	O
Sofa (Fabric) J-lounge, power recliner							S	S
Sofa (Leather) J-lounge, power recliner							O	O
GALLEY								
Countertop Flip-up Extension, Countertops solid-surface, Faucet single-control, Light fluorescent, under cabinet, Microwave Oven w/vented range fan, touch control, sensor cook feature, Sharp,® Pantry (33V w/dual pantries), Range 3-burner w/large oven, recessed, sealed burners, one w/high-output, Amana® Range Cover, Refrigerator/Freezer large double-door, Norcold,® Sink double-bowl molded w/sink covers (countertop material), Wastepaper Basket, Water Purification System w/separate faucet	S	S	S	S	S	S	S	S
Apothecary Drawers, Appliance Storage Cabinet		S						
Magazine Rack							S	S
Microwave/Convection Oven w/vented range fan, touch control, Sharp, Range Top 3-burner w/storage below, sealed burners, Amana, Refrigerator/Freezer large double-door w/ice maker, Norcold, Stainless Steel Package stainless steel appliances, brushed nickel lighting fixtures, decorative bath and cabinet hardware throughout	O	O	O	O	O	O	O	O
Refrigerator/Freezer 4-door w/ice maker, Norcold		O	O	O	O	O	O	O
Utility Tray tip-out		S					S	S
Wall Border	S		S	S	S	S	S	S
BATH								
Cabinet lavatory, Cabinet medicine, Countertops solid-surface w/backsplash, Faucet (lavatory) single-control, Faucet (shower) single-control, fixed shower head w/Moen Posi-Temp, Hair Dryer wall-mounted w/night-light, Light shower, Lights make-up, Shower Door textured glass, Shower Skylight, Sink oval, Tissue Holder, Toilet (porcelain) elongated bowl w/foot-pedal flush, Towel Rack 3-rod, mounted to door	S	S	S	S	S	S	S	S
Cabinet linen, Mirror			S					S
Magazine Rack			S		S			S
Robe Hook		S		S	S	S		
Shower w/wall surround	S	S	S	S		S	S	
Shower w/removable clothes rod			S					
Shower/Tub w/wall surround					S			
Showerhead hand-held					O			
Shower Package hand-held showerhead, fold-down shower seat	O	O	O	O	O	O	O	O
Towel Bar		S	S	S	S	S	S	S
Towel Ring	S			S	S			
Wall Border	S	S		S		S		
BEDROOM								
Bed queen, innerspring mattress, w/underbed storage, Bedspring, Lights decorative wall lamps, Nightstands (2), Pillows, Powerpoint 12-volt DC receptacle(s), Throw Pillow, Wardrobe Cabinet carpeted floor, clothes rod, drawers, light	S	S	S	S	S	S	S	S
Chest of Drawers								S
Desk w/folding chair					O			
Hamper tip-out		S	S		S	S	S	
Headboard	S		S	S	S			S
Mirror backwall	S	S	S	S		S	S	
Lounge Chairs (2) w/storage ottomans, Flexsteel®				S				
Sleep Number Bed queen by Select Comfort, remote holders	O	O	O	O	O	O	O	O
Vanity Cabinet w/fold-up countertop, folding chair	S		S		S			
Wall Border	S	S	S		S	S	S	S

- a The height of each model is measured to the top of the tallest standard feature and is based on the curb weight of a typically equipped unit. The actual height of your vehicle may vary by several inches depending on chassis or equipment variations. Please check with your dealer for further information.
- b Adventurer floorplans feature a wide-body design—over 96". In making your purchase decision, you should be aware that some states restrict access on some or all state roads to 96" in body width. Before making your purchase decision, you should confirm the road usage laws in the states of interest to you.
- c The load capacity of your motor home is designated by weight, not by volume, so you cannot necessarily use all available space when loading your motor home.
- d Capacities are based on measurements prior to tank installation. Slight capacity variations can result due to installation applications.

33V	35A	35U	37B	38G	38J	38R
EXTERIOR						
Awning Rails rain gutters, Door entrance w/separate screen door, deadbolt lock, Door fuel-fill, Entrance Door Steps electric w/doorjamb switch, Exterior Graphics Packages Lt. Autumnwood Metallic or Titanium Metallic, Ladder, Lights fog lamps, Light porch w/interior switch, Light driver-side service, Mirrors electric, remote w/delfrost, Mudflaps front & rear, Receptacle AC duplex, Sidewall Skin one-piece smooth fiberglass, high-gloss, Storage Compartments smooth valance panels, trunk liner, gas struts, TriMark® KeyOne System, paddle latch, lights	S	S	S	S	S	S
Awning patio	S		S	S		S
Awning patio, electric, w/wind sensor, remote	O	S	O	O	O	S
Front Protective Mask w/full body paint, Full Body Paint Sage or Denim, Undercoating Workhorse only	O	O	O	O	O	O
SYSTEMS						
Automotive Heater/Air Conditioner, Auxiliary Start Circuit, Batteries (Coach) (2) Group 24 deep-cycle, Battery (Coach) disconnect system, Battery Charge Control automatic dual, Drain 1" water tank, Electrical Distribution System AC & DC breaker panels, Generator 5,500-watt, Onan® Marquis Gold,™ gas, Generator/Shoreline Automatic Changeover Switch, Home Comfort Plus Package central air heat pump, auxiliary automotive heater, insulated powered ventilator fans (bath & galley), ONEPLACE Systems Center wall-mounted, battery digital voltmeter, energy management display, generator hourmeter gauge, generator start/stop switch, holding tank levels, LP tank level, solar panel/battery charger light, water heater switch & lights, water pump switch & light, water tank level, courtesy light, ceiling-mounted, Power Cord 30-amp., POWERLINE® Energy Management System, Service Compartment (Drainage/Water) city water hookup/tank diverter fill, drainage valves, exterior wash station w/pump switch, 10' sewer hose, QuickConnect coupling valve, QuickPort service connection hatch, Service Center (Electrical) cable input, power cord, QuickPort service connection hatch, telephone input, portable satellite dish hookup, Solar Panel 10-watt battery charger, Tank flushing system, black tank only, Tank holding, heated compartment, Tank LP, permanent mount w/gauge, TRUEAIR® Central Air Conditioning System, TRUELEVEL® Holding Tank Monitoring System, Water Heater 10-gallon electronic ignition, 120 vac/LP gas w/motoraid, Water System Winterization Package water heater bypass valve & siphon tube, Water Pump demand, permanent magnet motor w/diaphragm, Water Tank Fill gravity w/locking door (NA 38J)	S	S	S	S	S	S
Converter/Charger 45-amp. electronic	S		S			
Converter/Charger 55-amp. electronic		S		S	S	S
Furnace 35,000 BTU, low-profile	S					
Furnace 40,000 BTU, low-profile		S	S	S	S	S
Generator 7,000-watt, Onan Marquis Gold, gas, Inverter DC/AC, 300-watt, Power Cord 50-amp., flexible cord	O	O	O	O	O	O
Washer/Dryer Combination		O		O	O	O
Washer/Dryer Prep		S		S	S	S
SLIDEOUT						
Slideout Room (bed 33V, 35A; bed/wardrobe 35U, 38G, 38R; wardrobe 37B) w/slideroom cover	S	S	S	S	S	S
Slideout Room (bed) w/slideroom cover				S		S
Slideout Room (sofa/dinette) w/slideroom cover, STOREMORE	S	S	S	S	S	
Slideout Room (lounge/galley) w/slideroom cover, STOREMORE					S	S
Slideout Room (TV/dinette) w/slideroom cover, STOREMORE						S
Slideout Room (galley) w/slideroom cover, STOREMORE		S				
SAFETY						
Assist Bar interior, Assist Handle exterior, acrylic, Bumpers front & rear, Child Seat tether anchor, Detectors/Alarms LP leak, smoke, carbon monoxide, Fire Extinguisher 10 B.C., Ground Fault Interrupter, Light center high-mount brake lamp, Light courtesy w/wall switch, Lights daytime running lamps, Window escape, Windshield laminated safety glass	S	S	S	S	S	S
WARRANTY						
12-month/15,000-mile basic limited warranty,¹ 36-month/36,000 mile warranty on structure,¹ 10-year limited parts & labor warranty on roof skin¹	S	S	S	S	S	S

- e Capacities shown are tank manufacturer's listed water capacity (W.C.). Actual filled LP capacity is 80% of listing due to overfilling prevention device on tank.
- f Actual towing capacity is dependent on your particular loading and towing circumstances, which includes the GVWR, GAWR and GCWR, as well as adequate trailer brakes. Please refer to the Operator's Manual of your vehicle for further towing information.
- g Not all items available in combination. See dealer for details.
- h See separate chassis warranty details provided in owner's manual.
- i See your dealer for complete warranty information.
- Winnebago Industries' continuing program of product improvement makes specifications, equipment, model availability and prices subject to change without notice. Comparisons to other motor homes are based on the most recent information available.

NOT ALL MOTOR HOMES ARE CREATED EQUAL. As you take a closer look, you'll see that there is much more to the Winnebago Adventurer than a long list of standard features and compelling floorplans. Beneath it all you'll find a SuperStructure® foundation of strength and durability, and Winnebago Industries' recognized service and warranty support.



WE ARE COMMITTED TO SERVICE. We back our motor homes with the best after-the-sale service in the industry. This includes a 12-month/15,000-mile basic limited warranty; 36-month/36,000-mile warranty on structure; standard 10-year limited parts-and-labor roof skin warranty; and complimentary 24-hour Roadside Assistance Program. TripSaver Fast Track Parts guarantees that in-stock warranty parts ship directly to your dealer within 24 hours. Winnebago Industries has a nationwide dealer service network.



CERTIFIED QUALITY. Recreation Vehicle Dealer Association members annually rate RV manufacturers on the quality of their products, and on their sales and service support. Winnebago Industries has achieved the coveted Quality Circle Award every year since its inception, the only RV manufacturer to do so.



WARNING: JOINING WIT HAS BEEN KNOWN TO CAUSE EXCESSIVE FUN. Winnebago-Itasca Travelers (WIT) is a club for owners of Winnebago Industries motor homes. WIT is a great way to meet people and offers you caravans and rallies, local and state group activities, and other benefits for RVers.

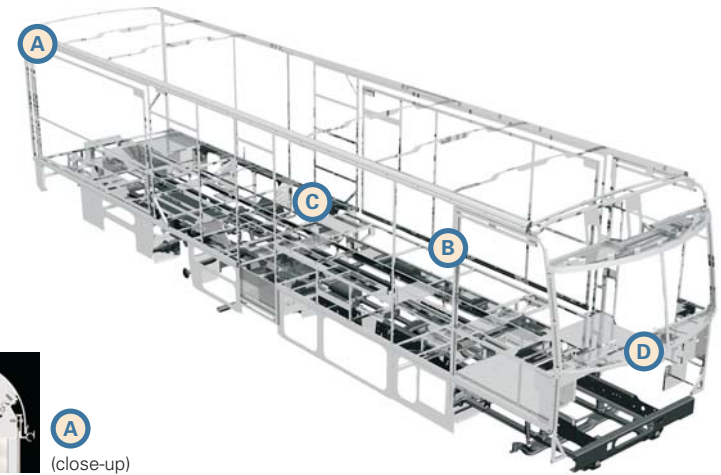

SUPERSTRUCTURE is the term given to Winnebago Industries' structural motor home design and construction. Rather than a single component, it is the culmination of design integration that incorporates steel and aluminum substructures; composite-design laminated floor risers; interlocking joint technology; and Thermo-Panel® floor, roof and sidewalls to form a high-strength, durable vehicle body.

Thermo-Panel manufacturing combines a durable exterior panel with welded aluminum support substructures. The substructures are embedded in a high-density, block-foam insulation core to create a strong, durable, yet lightweight sidewall. Just another Winnebago Industries' invention.

A Interlocking joint construction utilizes advanced extruded aluminum structural components to create integrated floor-to-sidewall and sidewall-to-roof joints. This design effectively distributes the weight of the walls and roof, making a stronger and more durable body than competitor designs that rely on screws to carry the weight.

B The foundation substructure assembly is precision-aligned to maximize strength and cross-coach support as well as durability.

C Laminated risers feature a welded aluminum core for superior strength and provide a stable base for the floor structure and storage compartments.

D Critical steel components are treated using an advanced electrodeposition coating process that provides superior corrosion protection.



One-year-old competitor's rubber roof



One-year-old Winnebago Industries fiberglass roof

BUILT TO A HIGHER STANDARD.

The Adventurer features a crowned, one-piece fiberglass roof skin backed with a 10-year limited parts-and-labor roof skin warranty. Fiberglass offers superior strength, attractiveness and durability compared to rubber roofs found on many competitive models. Over time, rubber roofs are susceptible to chalking, streaking and degradation, and have less puncture and tear resistance than fiberglass.



©2004 Winnebago Industries, Inc., Forest City, IA 50436. Printed in USA.

Seat belts are your most important hookup. Always buckle up.

NYSE listing: WGO

Visit us at www.winnebagoind.com